

Installation Guide

Smart-UPS[™] C 1000/1500 VA 120/230 Vac 2000/3000 VA 230 Vac Rack-Mount 2U

Important Safety Messages

SAVE THESE INSTRUCTIONS - This manual contains important instructions that should be followed during installation and maintenance of the Smart-UPS and batteries.

Read these instructions carefully and look at the equipment to become familiar with the device before trying to install, operate, service or maintain it. The following special messages may appear throughout this document or on the equipment to warn of potential hazards or to call attention to information that clarifies or simplifies a procedure.



The addition of this symbol to either a “Danger” or “Warning” safety label indicates that an electrical hazard exists which will result in personal injury if the instructions are not followed.



This is the safety alert symbol. It is used to alert you to potential personal injury hazards. Obey all safety messages that follow this symbol to avoid possible injury or death.

DANGER

DANGER indicates a hazardous situation which, if not avoided, will result in death or serious injury.

WARNING

WARNING indicates a hazardous situation which, if not avoided, could result in death or serious injury.

CAUTION

CAUTION indicates a hazardous situation which, if not avoided, could result in minor or moderate injury.

NOTICE

NOTICE is used to address practices not related to physical injury.

Product Handling Guidelines

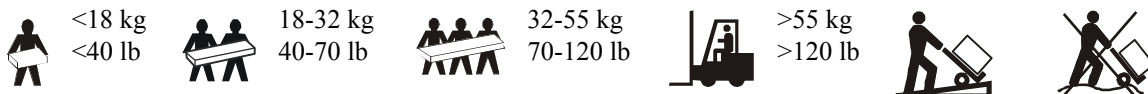

Safety and General Information

Inspect the package contents upon receipt. Notify the carrier and dealer if there is any damage.

Read the Safety Guide supplied with this unit before installing the UPS.

- Adhere to all local and national electrical codes.
- This UPS is intended for indoor use only.
- Do not operate this UPS in direct sunlight, in contact with fluids, or where there is excessive dust or humidity.
- Be sure the air vents on the UPS are not blocked. Allow adequate space for proper ventilation.
- The battery typically lasts for two to five years. Environmental factors impact battery life. Elevated ambient temperatures, poor quality utility power, and frequent short duration discharges will shorten battery life.
- Connect the UPS power cable directly to a wall outlet. Do not use surge protectors or extension cords.

Radio Frequency Warning

WARNING: This is a category C2 UPS product. In a residential environment, this product may cause radio interference, in which case the user may be required to take additional measures.

Note: This equipment has been tested and found to comply with the limits for a Class A digital device, pursuant to part 15 of the FCC Rules. These limits are intended to provide reasonable protection against harmful interference when the equipment is operated in a commercial environment. This equipment generates, uses, and can radiate radio frequency energy and, if not installed and used in accordance with the instruction manual, may cause harmful interference to radio communications. Operation of this equipment in a residential area is likely to cause harmful interference in which case the user will be required to correct the interference at his own expense.

Inventory

All models



(2)
Documentation CD x 1
PowerChute Software CD x 1

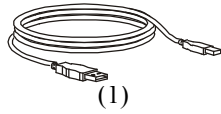

(1)

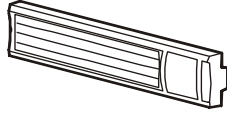

(1)



(2)



(4)



(1)
Installation Guide

1000/1500/2000/3000 VA 230 Vac models

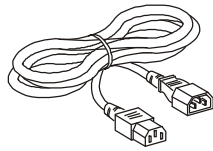

(2)

1000VA 120/230 Vac models

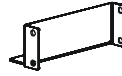

(2)



(4)



(2)



(2)



(2)

2000/3000 VA 230 Vac models

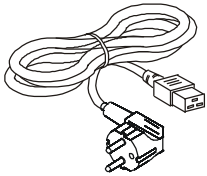

(1)

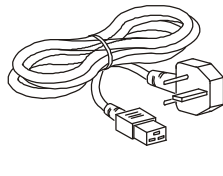

(1)

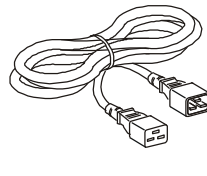

(1)

Product Overview

Rear Panel features

1000 VA 120 Vac

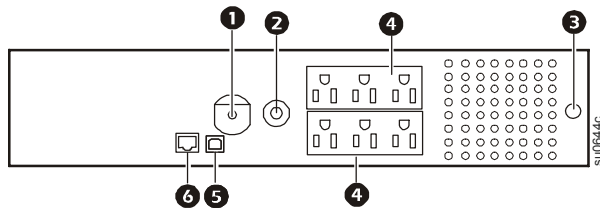

1000 VA 230 Vac

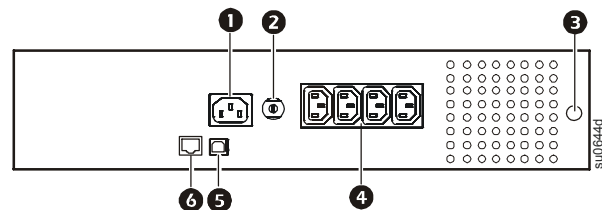

- ① UPS input
- ② Circuit breaker/Overload protection
- ③ Chassis ground screw

- ④ Outlets
- ⑤ USB port
- ⑥ Serial data port

1500 VA 120 Vac

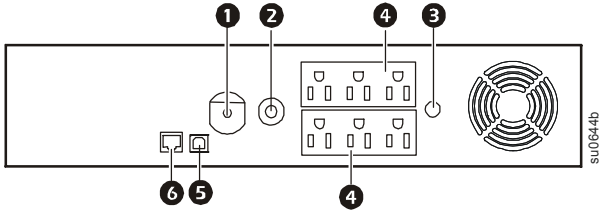

1500 VA 230 Vac

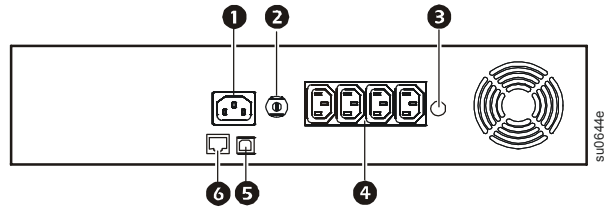

2000 VA 230 Vac

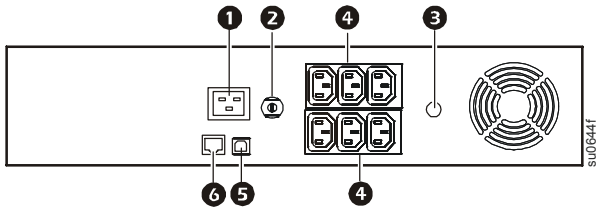

3000 VA 230 Vac

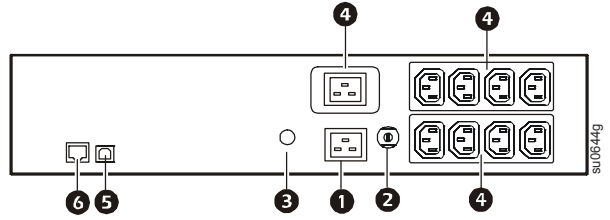

- 1 UPS input
- 2 Circuit breaker/Overload protection
- 3 Chassis ground screw

- 4 Outlets
- 5 USB port
- 6 Serial data port

Front panel features

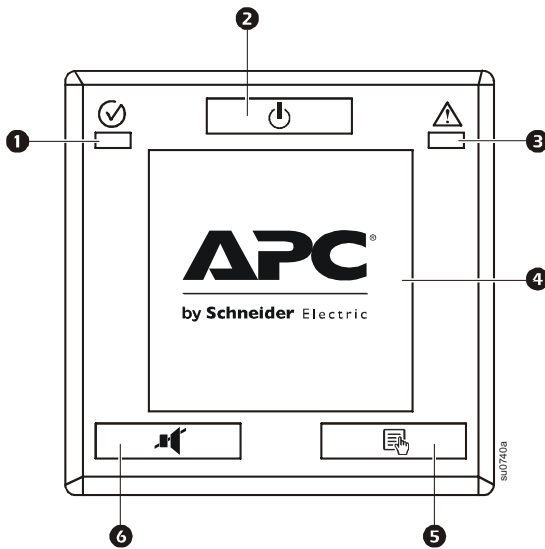

- 1 Online/On Battery LED
- 2 POWER ON/OFF button
- 3 120 Vac models only:
Site Wiring Fault/Alert LED
- 4 Display interface
- 5 DISPLAY button
- 6 MUTE button

Installation

1000 VA 120/230 Vac Models

1

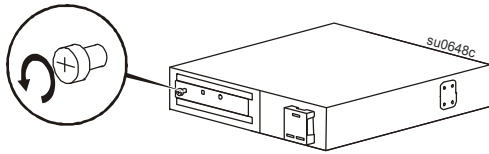

2

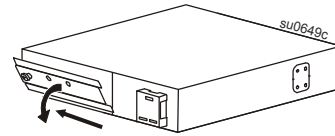

3

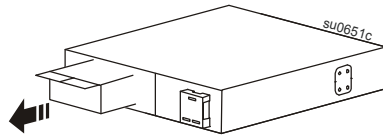

4

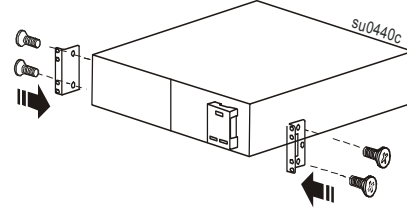

Two post rack installation

1

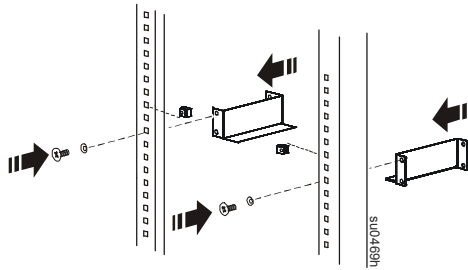

2

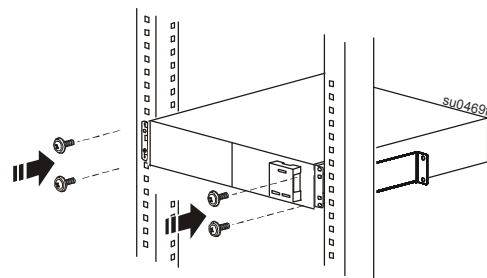

Four post rack installation

1

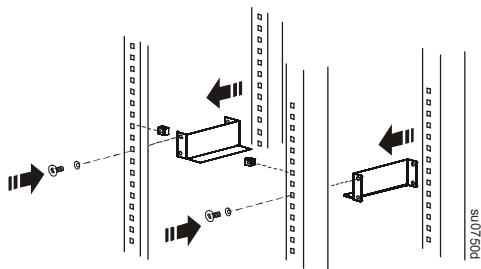

2

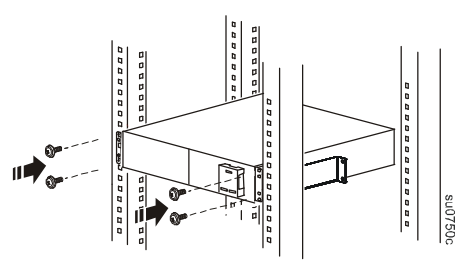

Install the battery

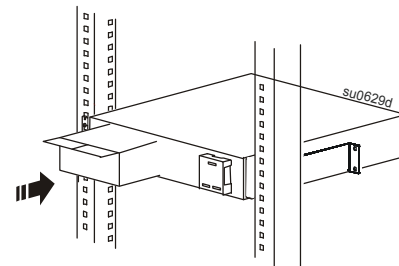
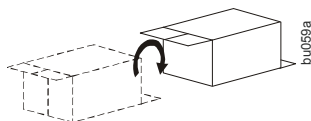

Secure the battery compartment door

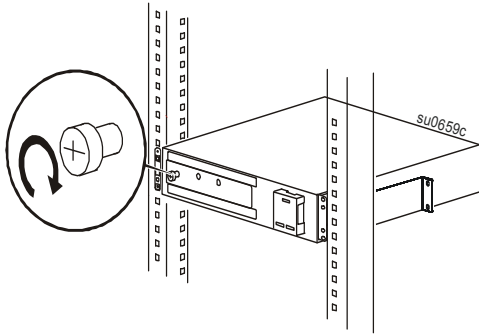

Install the bezel

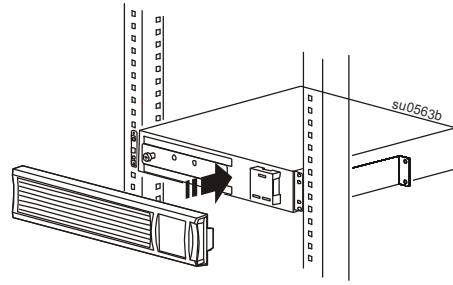

1500 VA 120/230 Vac and 2000 VA 230 Vac Models

1

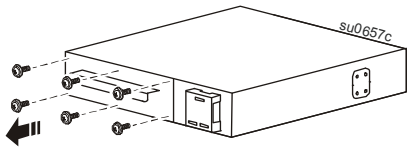

2

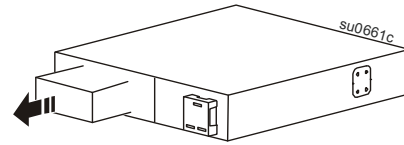

3

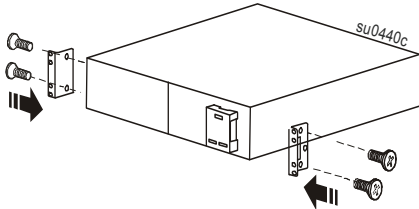

Two post rack installation

1

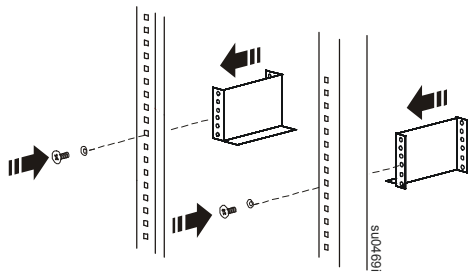

2

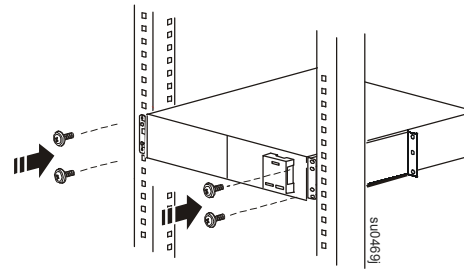

Four post rack installation

1

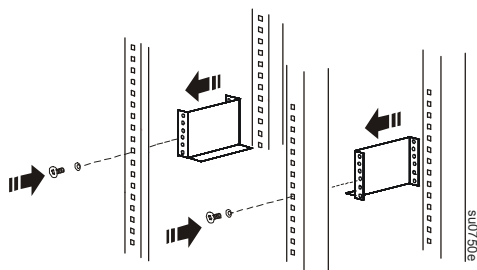

2

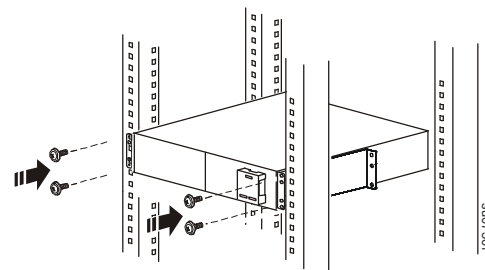

Install the battery

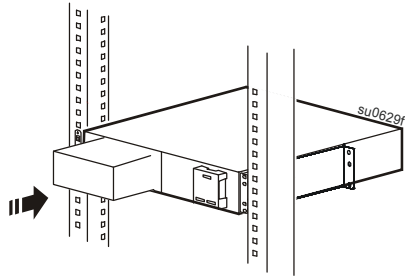

Connect the battery

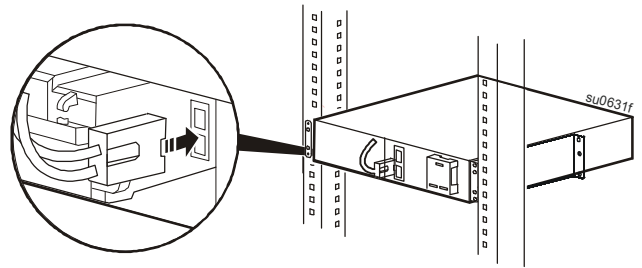

Secure the battery compartment door

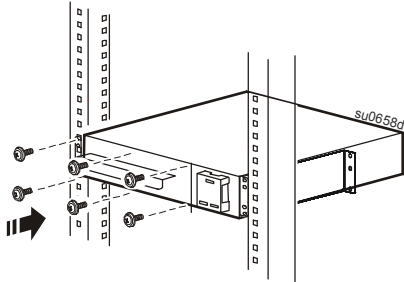

Install the bezel

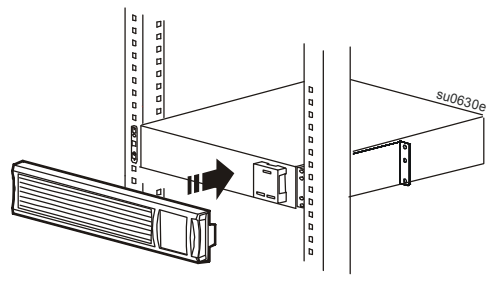

Connect equipment to the UPS and connect the UPS to AC power

⚠ CAUTION

RISK OF ELECTRIC SHOCK

- Adhere to all local and national electrical codes.
- Wiring must be performed by qualified electrician.
- Always connect the UPS to a grounded outlet.

Failure to follow these instructions can result in minor or moderate injury

